

## Double Box with TwinCONTACT

Part no. 1648



- screwless spring terminals
- CEE and socket SCHUKO® in one enclosure

### Technical specifications

CEE 16 A, 4 p, 400 V	1
SCHUKO® 16 A, 230 V	1
Protection type	IP 44
Shutter	false
Enclosure material	Plastic
Weight	380 g
Declaration of Conformity	EAC

### Drawing

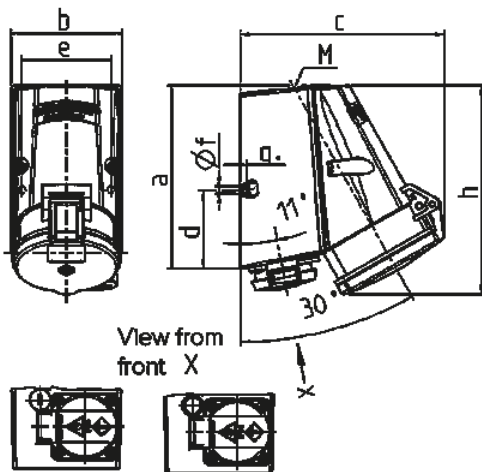

Drawing	Amp.	16		32
		4	5	5
<b>1 MB 354</b>	<b>Poles</b>			
<b>Dim. in mm</b>	<b>a</b>	141	141	141
	<b>b</b>	84	84	85
	<b>c</b>	136	140	158
	<b>d</b>	61	61	61
	<b>e</b>	68	68	68
	<b>f</b>	5.5	5.5	5.5
	<b>g</b>	5	5	5
	<b>h</b>	142	145	161
	<b>M</b>	25	25	25
	<b>Max. cable diam. (mm)</b>	18	18	18
	<b>Terminal for cond. cross section (mm<sup>2</sup>) min.-max.</b>	1.5	1.5	2.5
		—4	—4	—10