

Wall mounted receptacle DUO

Part Number.: 5601506G



MENNEKES

Elektrotechnik GmbH & Co. KG
Aloys-Mennekes-Straße 1
57399 KIRCHHUNDEM GERMANY
www.MENNEKES.org

Product Description

- Screw terminals
- Pre-wired for installation
- X-CONTACT®
- Switched
- Mechanical DUO interlock
- 3 pole switch
- Sockets can be padlocked

Technical Details

Wall mounted receptacle - DUO	5601506G
Product series	DUO
Switch Disconnecter	Yes
Ampere	16 A
Number of Poles	5 P
Clock position	6 h
Voltage	400 V
Hertz	50-60 Hz
Current Type	AC
Switch Type	3P + N + PE
Protection Type	IP44
Impact resistance	IK08
Contact carrier	X-CONTACT®
Pilot contact	Without pilot contact
Connection	Screw-terminals
LED voltage indicator	No

Padlocked	Yes
Mounting method	Wall mounted
Cable entry	Top & Bottom 2 x M25 top or bottom closed 1 x M25 and 1 x M32 top or bottom closed
Weight (net)	1201 g
EAN / identification number	4015394298052

Permissible ambient conditions

Permanent ambient temperature min. - max.	-25 - +40 °C
---	--------------

Material properties

Hinged lid	PC similar RAL 3013 red
Upper enclosure part	PC/ASA similar RAL 7035 grey
Enclosure base	PC/ASA similar RAL 9005 deep black
Rotary Switch	PC/ASA similar RAL 7035 grey
Material of exterior screws	PA6 similar RAL 9005 deep black

Material resistance

The material resistance overview can be found on the website in the "Knowledge" section → "Product knowledge" → "Materials"

Regulations and Standards

REACH (Regulation (EG) No. 1907/2006)	Information according to article 33 REACH: SVHC: Lead (CAS: 7439-92-1)
RoHS 2011/65/EU incl. 2015/863/EU	✓
POP Regulation (EU) 2019/1021	✓
Norm(s)	IEC 60309-4
Declaration of conformity	CE, UKCA
Test mark	VDE, EAC

Dimensional drawing

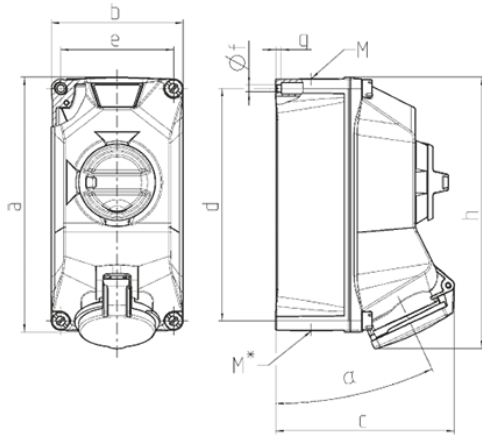

Drawing 1 MB 713 Dim. in mm	Amp. Poles	16			32		
		3	4	5	3	4	5
a		225	225	225	225	225	225
b		118	118	118	118	118	118
c		160	160	160	162	162	162
d		208	208	208	208	208	208
e		101	101	101	101	101	101
f		6.4	6.4	6.4	6.4	6.4	6.4
g		5	5	5	5	5	5
h		238	244	243	249	249	250
α			25			25	
M		1x25 and 1x32			1x25 and 1x32		
M*		2x25	2x25	2x25	2x25	2x25	2x25
Max. cable diam. (mm)		25	25	25	25	25	25
Terminal for cond. cross section (mm ²) min.-max.		2.5	2.5	2.5	2.5	2.5	2.5
		-10	-10	-10	-10	-10	-10